

www.dabaloprema.hr

PRIMJENE:

- ✓ ELEKTRONIČKA SKLOPKA PROTOKA
- ✓ ZAŠTITA OD RADA NA SUHO







ZNAČAJKE

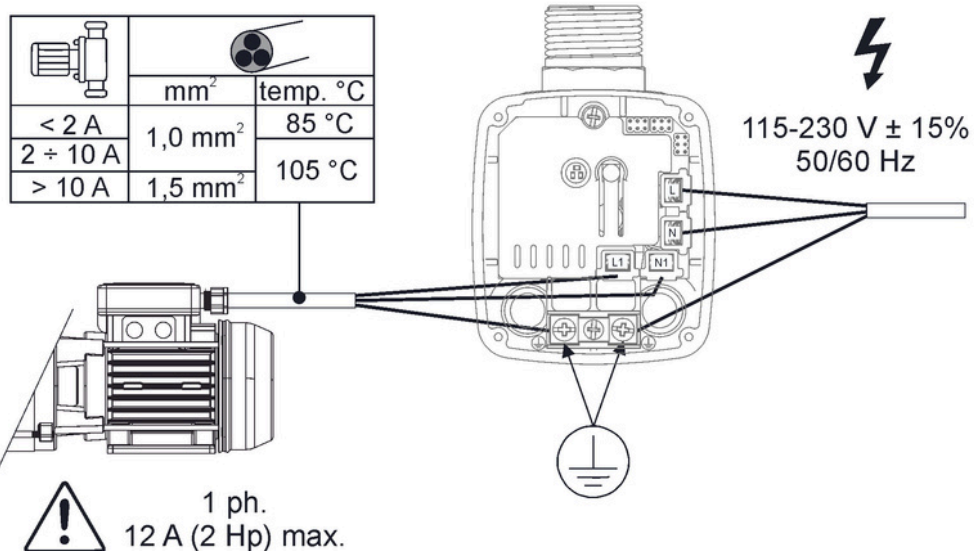
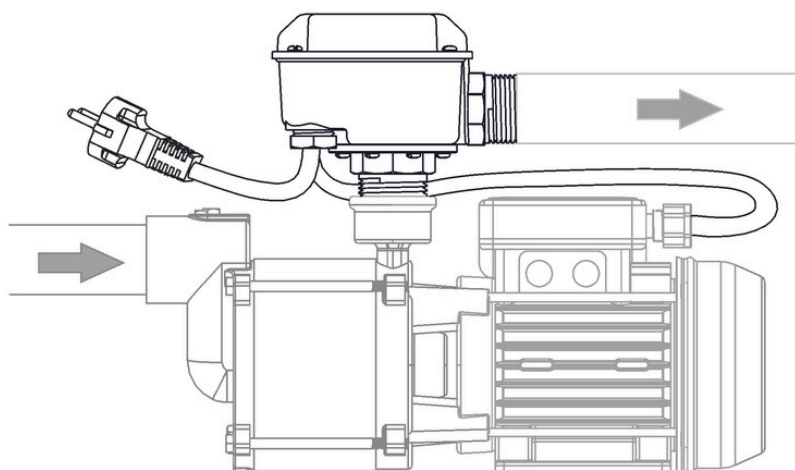





- Vremenski programirana sklopka za punjenje i pražnjenje spremnika za električne pumpe do 2 KS.
- Štiti od rada na suho.
- Unutarnji ventil za detekciju protoka vode dizajniran da omogući pražnjenje vodenog stupca.
- Podesiva odgoda isključivanja pumpe
- Interval automatskog ponovnog postavljanja i podesivi broj pokušaja (interval između testova 15-30-60-120 minuta, pokušaji 6-12-24-beskonačno).
- Jednostavna zamjena elektroničke kartice.
- Minimalni protok za kontinuirani rad crpke smanjen na 2 lt/min.
- Mogućnost prisilnog rada crpke radi lakše prve instalacije.
- Inovativan i kompaktan dizajn, s priključkom pod 90 stupnjeva za brzo i jednostavno povezivanje u svakoj situaciji.

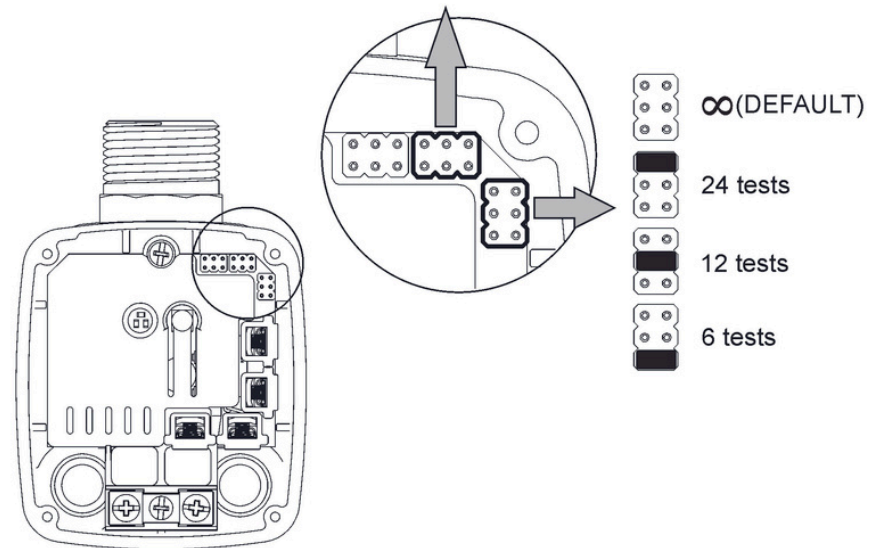

Automatsko resetiranje koje se može postaviti tijekom instalacije zahvaljujući elektroničkoj kartici najnovije generacije.

-  30 min. (DEFAULT)
-  15 min.
-  60 min.
-  120 min.





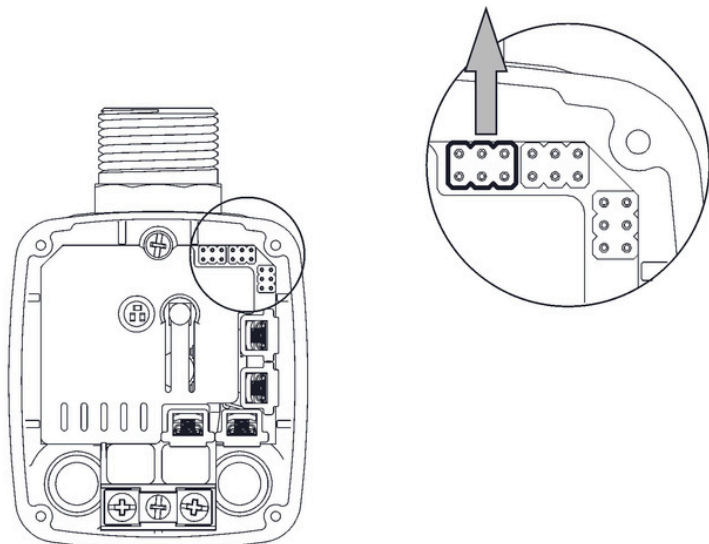





-  10 sec. (DEFAULT)
-  30 sec.
-  60 sec.
-  120 sec.



Argo jamči kontinuitet rada čak i uz minimalni protok od 2 lt/min u vašem sustavu za punjenje i pražnjenje spremnika.

Inovativan i kompaktan dizajn, s priključkom od 90 stupnjeva za brzo i jednostavno povezivanje u svakoj situaciji.

	115-230 V 50/60 Hz
	1ph. - 12 A max.
	IP 65
	10 bar max.
	5 ÷ 55 °C.
	-10 ÷ 50 °C RH < 95 %
	-10 ÷ 70 °C RH < 95 %
	5 ÷ 45 °C RH < 85 %